









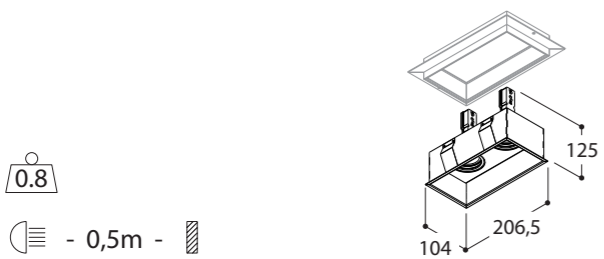

name	MINI RASPUTIN GU10	
ref	211618 1x GU10 TEXTURED WHITE 211626 1x GU10 TEXTURED BLACK	
		
ACCESSORIES		
*	720199 MINI FRAME FOR PLASTER  112 x 112 x 130 mm	
	702210 MINI FRAME + BOX FOR CONCRETE  200 x 235 x 180 mm	
ref	211628 2x GU10 TEXTURED WHITE 211636 2x GU10 TEXTURED BLACK	
		
ACCESSORIES		
*	720299 MINI FRAME FOR PLASTER  213 x 112 x 130 mm	
	702220 MINI FRAME + BOX FOR CONCRETE  260 x 235 x 180 mm	
GENERAL INFORMATION		
lamptype	QPAR16 alu refl. or Perfect fit Ledlamp** (masterled***)	
fitting	GU10	
watt	35 - 50W / 8W* //module	
voltage or current	230V 50Hz AC	
symbol	 (***)	
gear	Mains voltage	
ip/class	IP20 	
application	Interior - trimless - downlight 	
orientability	359° - 30° 	
dimmbility	R or see Perfect fit ledlamp**	
	(***)for Masterled use installation depth 150mm)	

-  ALWAYS DISCONNECT POWER SUPPLY BEFORE INSTALLING THE LUMINAIRE.
-  MINIMUM CEILING THICKNESS: 12,5mm
MAXIMUM CEILING THICKNESS: 25mm

- ① Make hole according to luminaire model and type of accessory*
(***for Masterled use installation depth 150mm)

② Build in frame

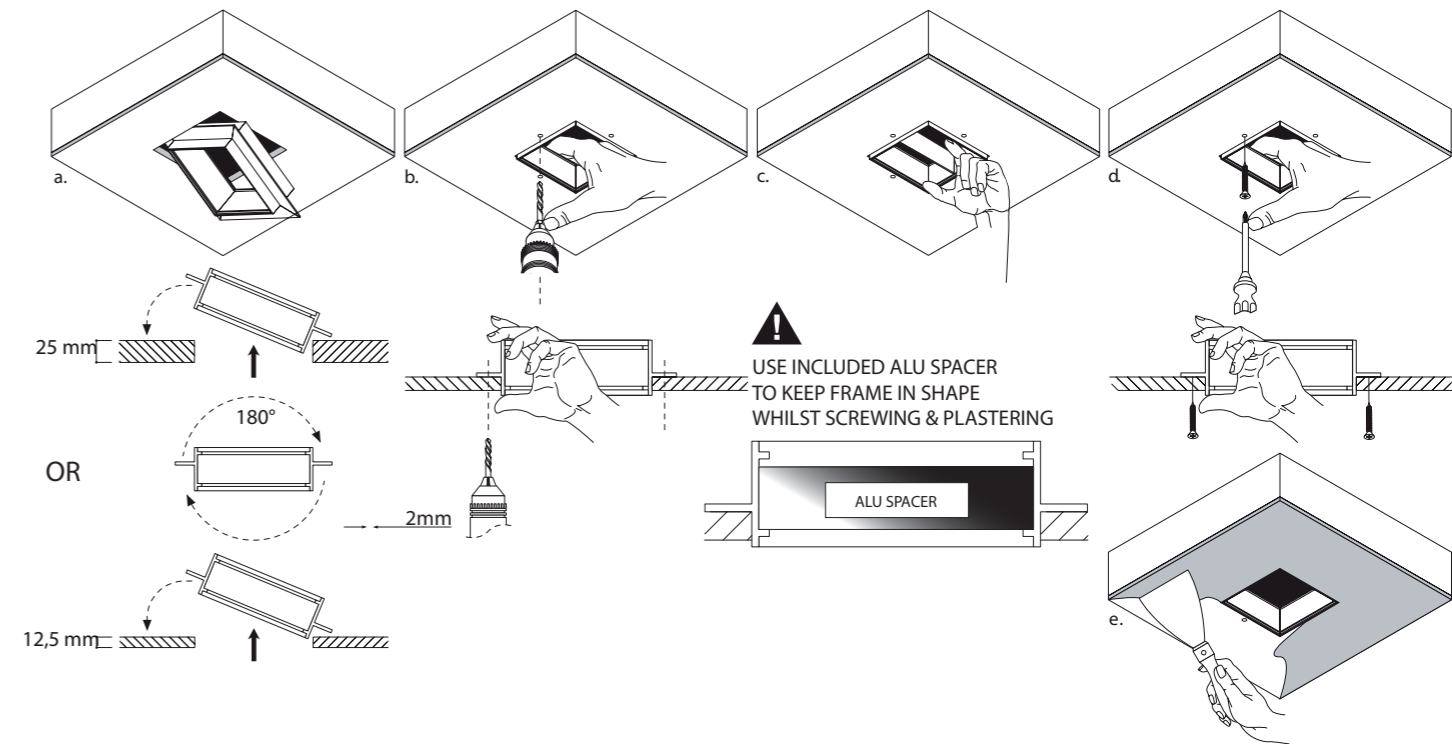

③ Make electrical connection / module

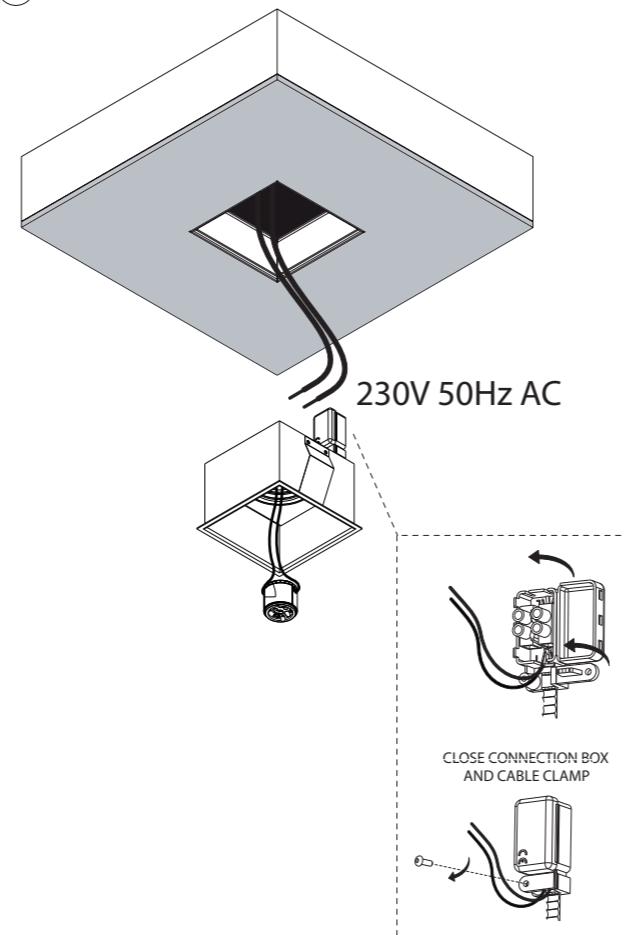

④ Click luminaire into frame

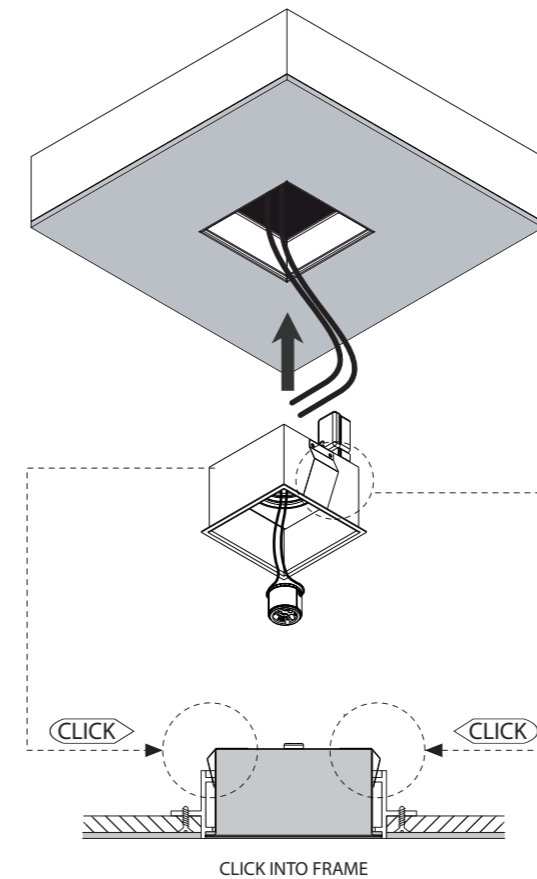

⑤ Mount the lamp & switch on mains power supply

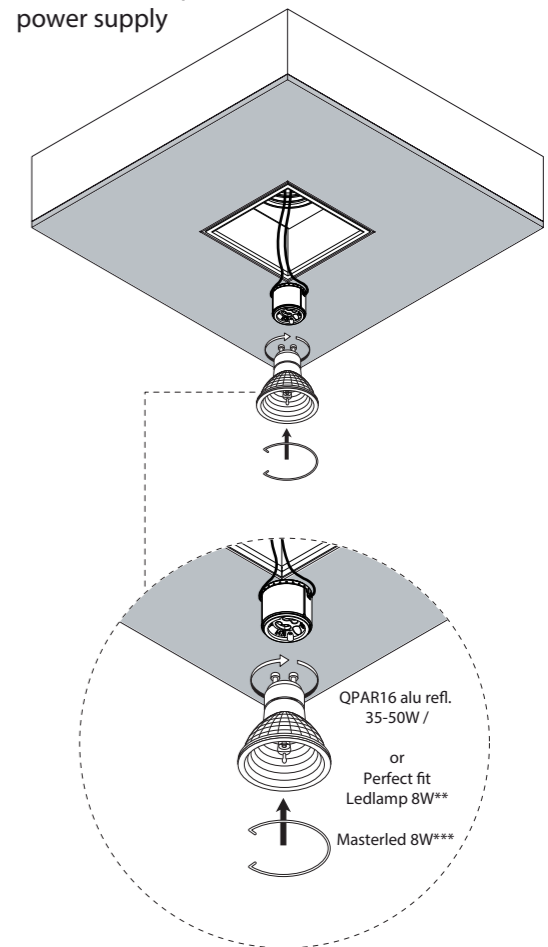

INSTALLATIE- EN ONDERHOUDSRICHTLIJNEN m.b.t. FABRIEKSGARANTIE.
 1. DE VERBINDINGEN EN HET UITTESTEN VAN DEZE TOESTELLEN DIENEN ALTIJD TE GEBEUREN DOOR EEN ERKEND ELECTRO-INSTALLATEUR.
 2. DEZE VERLICHTINGSTOESTELLEN MOETEN GE-INSTALLEERD, VERBONDEN EN GETEST WORDEN VOLGENS DE NATIONAAL GELDENDE REGLEMENTEN OP DE ELECTRIISCHE INSTALLATIES (BELGIE*, A.R.E.I., DUITSLAND: DIN VDE 0100 TEIL 559 A2, ...; DEZE OPSOMMING IS LOUWER INFORMATIEF).
 3. DE TECHNISCHE BUSLUITER MOET GEZIEN WORDEN ALS ONDERDEEL VAN DE ALGEMENE VERKOOPVOORWAARDEN VAN TAL N.V.
 4. DE ELECTRO-INSTALLATEUR IS VERANTWOORDELIJK VOOR HET GEBRUIKEN VAN VOORSCHAKELAPPARATUUR DIE VOLDOET AAN DE GELDENDE CE EN EMC NORMEN.
 5. VERVANG DE LAMP (-EN) ALTIJD MET DE GROOTSTE ZORG, ZE IS (ZIJN) UITERST BREEKBAAR.
 6. OPGEPAST: PLAATS NOOIT DE LAMP MET BLOTE HANDEN, GEBRUIK ALTIJD EEN DOEK!

INSTRUCTIONS D'INSTALLATION ET D'ENTRETIEN A RESPECTER VIS-A-VIS DE LA GARANTIE.
 1. LE PLACEMENT, LE RACCORDEMENT ET L'ESSAI DE CET APPAREIL DOIVENT TOUJOURS ENTRE EFFECTUES PAR UN INSTALLATEUR ELECTRICIEN AGREE.
 2. LES LUMINAIRES DOIVENT ETRE INSTALLEZ, BRANCHES ET TESTES SUIVANT LE REGLEMENT NATIONAL SUR LES INSTALLATIONS ELECTRIQUES EN VIGUEUR. (BELGIQUE, A.R.E.I., ALLEMAGNE: DIN VDE 0100 TEIL 559 A2, ...; CETTE ENUMERATION EST INDICATIVE)
 3. CE MANUEL D'INSTALLATION TECHNIQUE REPRESENTE UNE PARTIE DES CONDITIONS GENERALES DE VENTE DE TAL N.V.
 4. L'ELECTRO-INSTALLATEUR EST RESPONSABLE POUR L'USAGE DE BALLASTS, TRANSFO'S,...CONFORMES AUX NORMES CE ET EMC EN VIGUEUR.
 5. REMPLACEZ TOUJOURS L'AMPOULE (LES AMPOULES) AVEC PRUDENCE; ELLE(-S) EST (SONT) TRES FRAGILE (-S).
 6. ATTENTION: NE JAMAIS REMPLACER L'AMPOULE AUX MAINS NUES, UTILISEZ TOUJOURS UN CHIFFON!

INSTALLATION AND MAINTENANCE INSTRUCTIONS IN VIEW OF THE MANUFACTURER'S GUARANTEE.
 1. THE CONNECTION AND TESTING OF THE DEVICES SHOULD ALWAYS BE PERFORMED BY A RECOGNIZED ELECTRICIAN.
 2. THESE LIGHTING DEVICES NEED TO BE INSTALLED, CONNECTED AND TESTED FOLLOWING THE OFFICIAL NATIONAL INSTRUCTION GUIDE FOR ELECTRICAL INSTALLATIONS (BELGIUM, A.R.E.I., GERMANY: DIN VDE 0100 TEIL 559 A2, ...; THIS ENUMERATION IS JUST AN INDICATION)
 3. THIS TECHNICAL ENCLOSURE NEEDS TO BE ADDED TO THE GENERAL SALES CONDITION OF THE TAL N.V.
 4. THE ELECTRO TECHNICIAN IS RESPONSABLE TO USE BALLASTS, TRANSFORMERS,...WHICH MEET THE VALID CE AND EMC RULES.
 5. ALWAYS REPLACE THE LAMP (-S) WITH UTMOST CAUTIONSNESS, THE LAMP (-S) IS (ARE) VERY FRAGILE.
 6. ATTENTION: NEVER REPLACE THE LAMP WITH BARE HANDS, ALWAYS USE A CLOTH!

MONTAGE- UN UNTERHALT INSTRUCTIONEN ZU BEACHTEN MIT BEZUG AUF DER GARANTIE.
 1. DIE MONTAGE, DER ANSCHLUSS UND DAS AUSTESTEN DER LEUCHTEN SOLL IMMER VON EINEM ZUSTAENDIGEN ELECTRO-INSTALLATEUR AUSGEFUHRT WERDEN.
 2. DIESE LEUCHTEN MUSSEN INSTALLIERT, ANGESCHLOSSEN UND GETESTET WERDEN NACH DER ALLGEMEINEN NAZIONALEN REGLEMENTATION UBER DIE ELEKTRISCHE INSTALLATIONEN (BELGIEN, A.R.E.I., DEUTSCHLAND: DIN VDE 0100 TEIL 559 A2, ...; DIESE AUFSTELLUNG GESCHICHT DURCH EXEMPLATIVEN TITEL UND KANN NICHT ALS LIMITATIV ODER EXHAUTIV BETRACHTET WERDEN).
 3. DIESE TECHNISCHE GEBRAUCHSANWEISUNG GEHORT ZU DEN ALLGEMEINEN VERKAUFSBEDINGUNGEN VON TAL N.V.
 4. DER ELEKTRO-INSTALLATEUR IST VERANTWORTLICH FUR DAS VERWENDEN VON CE UND EMC GEPRUFTE VORSCHALTGERATE.
 5. DIE LAMPE(-N) SOLL(-EN) IMMER SERH VORSICHTIG ERSAETZT WERDEN.
 6. VORSICHT: MAN DARF NIE DIE LAMPE MIT DEN NACKTEN HAENDEN BERUHREN, MAN SOL IMMER EINEN TUCH BENUTZEN!